

Data Sheet



Article number: 0121049

Description: Retaining ring JL 32X1,2
Spring steel

Measures

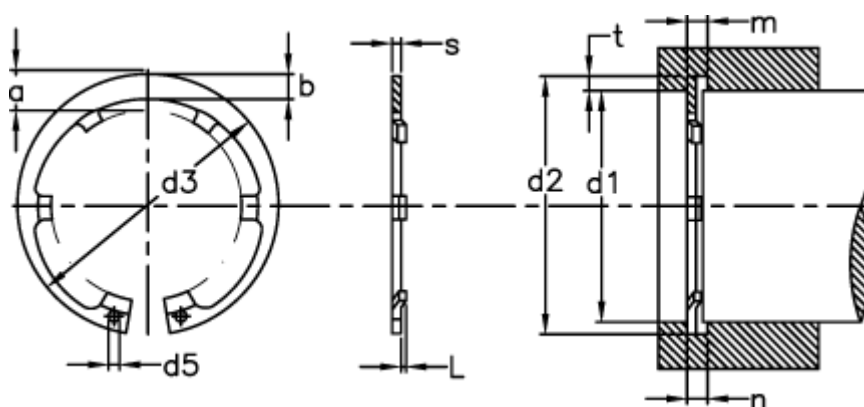

a max	= 5.1	FL max kN	= 0.39	s	= 1.20
b	= 3.3	FN kN	= 14.6	tol	= 0.25
C kN/mm	= 1.55	FRg kN	= 4.60	tol	= +0,50 -0,25
d1	= 32	FR kN	= 13.80	u	= 0.10
d2	= 33.7	g	= 1.0		
d3	= 34.4	L min	= 0.35		
d5 min	= 2.5	m min	= 1.30		
Description	= AL 32	Nominal drive	= 2.5		